

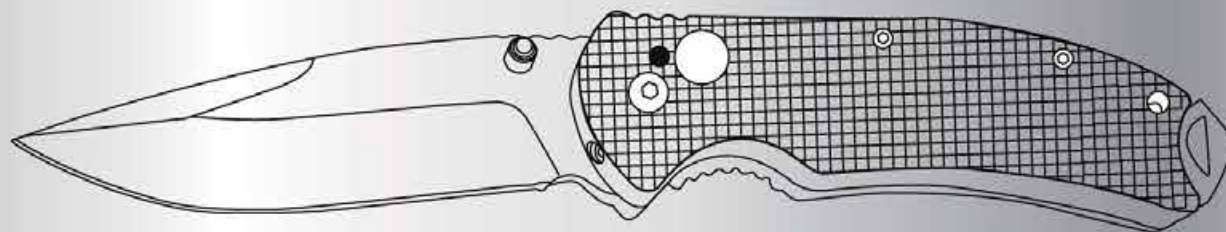

HENSTRONG INDUSTRIAL & TRADING CO.,LTD

Is a leading manufacturer and exporter of multi-purpose tools and knives

2018 KNIFE CATALOG





HENSTRONG INDUSTRIAL & TRADING CO.,LTD

» **Company Profile**

Henstrong Industrial and Trading Co., Ltd. located at Yangjiang, Guangdong, is a leading manufacturer and exporter of multi-purpose tools such as Pocket Knives, Army Knives, Multi-purpose Pliers, Multi-purpose Knives, Multi-purpose Hammers, Tactical Pen and etc. in China. We founded in 1985, And we have :

- factory covering 40,000 m².
- 500 workers, 30 engineers.
- Strong R&D team, over 100 own patented products. ODM & OEM service are welcome.
- Own heat treat process, 15 fine blanking machines, 33 wire cutting machines.
- ISO9001-2008 quality system for strict quality control.
- products with RoHs, CE, REACH and other certificates
- Having long-term good business relationship with supermarket and many famous Brands in the world. Such as: Home Depot, Lowe's, OBI, Bahco, Buck, Gerber, Snap-on, Stanley and etc.
- Assigned to be the exclusive manufacturer of Military Knives for public security officers and SWAT teams by the Ministry of Public Security of the People's Republic of China.

Cooperative Brands



» Reputation

- 2001, "Scientific and Technological Private Enterprise of Guangdong Province"
- 2002、2003: "Advanced Taxpayer"
- 2003、2004: "Enterprise with Integrity & Credit"
- 2005: "Top 10 Enterprises of Yangjiang City"
- 2006: "Excellent Private Enterprise of Yangjiang City"
- 2006: "High-tech Enterprise of Guangdong"
- 2008: "Guangdong Famous Trademark"
- 2008: "Guangdong Top Branded Products (knives)"
- 2010: "Guangdong Top Branded Products (pliers)"
- 2011: "Guangdong Famous Trademark"
- 2012: "Guangdong Famous Trademark"
- 2013: "Guangdong Famous Trademark"

» R & D

- Dedicated to build our company into an industrial benchmark
- The 1st manufacturer to set up Fine Blanking Line
- No. 1 manufacturer to use Fine Blanking technology
- Patents: possess 100 patented products

» Vision

"Make pioneering efforts; quality, credit always comes first" are our consistent business principle. We believe everything can always be improved. We seek these improvements at each step, from products design, tooling, production, and packaging to final delivery. Holding the relentless pursuit of perfection, we aimed to be the best value provider in the supply chain of Multi Tools industry.

» Strong point

1. Built a new flagship tools factory in 2010, occupied 40,000 m² of land, and possessed 100,000 m² of working place. The best image among Yangjiang manufacturers, human rights care, environmental friendly, working for top brands and top retailers worldwide.
2. Assigned to be the exclusive manufacturer of Military Knives for public security officers and SWAT teams by the Ministry of Public Security of the People's Republic of China.
3. The first and still the number 1 factory that practice Fine Blanking Technique in China, which is unique in this line.
4. Strictly adhere to NDA, reliable OEM service; closely work with Home Depot, Lowe's, Buck, Stanley, Gerber and etc.
5. Top quality guaranteed, inferior goods under 0.5%
6. Strong R&D ability, patented items 50.
7. 600 workers, 30 engineers
8. 30 years of experience
9. Passed ISO9001-2000 International Quality Attestation System in 2006.
10. Strict quality control system, prompt delivery, management team with profound multi-tool Industrial background.



HENSTRONG INDUSTRIAL & TRADING CO.,LTD

PRODUCT CATALOG

New Products4-9

- ONE** — *Survival Knife10-19*
- TWO** — *Outdoor Knife20-68*
- THREE** — *Damascus knife69-71*
- FOUR** — *Hunting Knife72-74*
- FIVE** — *Tactical Pen75-78*

Structure Patent Belongs to Henstrong

H-K2490270

Blade:Stainless Steel 420
Handle:G10
Closed: 113mm
Open: 200mm
Weight: 129g
Style:Folding knife with liner lock
Features: LED,Belt Cutter, USB Charge



More Colors:



Structure Patent Belongs to Henstrong

H-K201064-1

Blade frame: Stainless
 Blade: Carbon Steel 420
 Handle: Aluminum
 Closed: 108mm
 Open: 173mm
 Weight: 155g
 Style: Utility Knife



H-K201064

Blade frame: Stainless
 Blade: Carbon Steel 420
 Handle: Aluminum
 Closed: 108mm
 Open: 173mm
 Weight: 178g
 Style: Utility Knife



More Colors:



Liner lock, more safety.



Quick release button, which is own patent, more easy to change the blade.



H-K2010024

Blade: Edge:Plain
Steel:Stainless Steel 420
Thickness:2.5mm
Length:72mm
Finish:Sand Blasting

Closed:108mm
Open:180mm
Weight:118g
Handle:Plastic
Style:Frame Lock



H-K2010024



H-K2490274

H-K2490274

Blade:74mm
Closed:106mm
Open:180mm
Weight:115g
Handle:Plastic
Style:Frame Lock



H-K2010021

Blade:Stainless Steel 420
Handle:Plastic with rope
Closed:122mm
Open:215mm
Weight:123g
Style:Folding knife with liner lock



More Colors:



H-KD16002

Blade: Damascus steel
Handle: stainless steel 420 with Wood
closed: 120mm
Open: 205mm
Weight: 129g
Style: Folding knife with liner lock



H-O240182

Tactical Pen with LED
Material:Aluminum
Size:160*15mm
Weight:49g

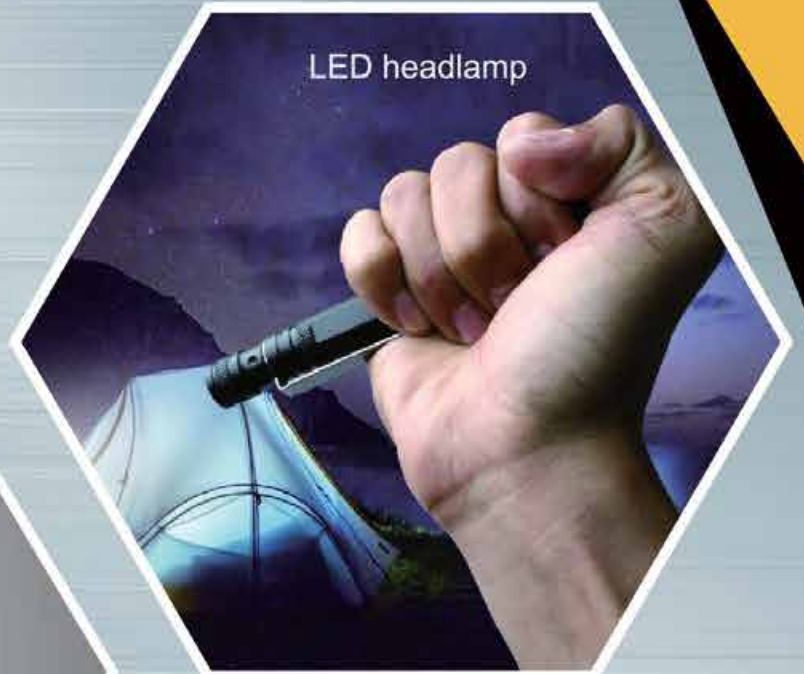
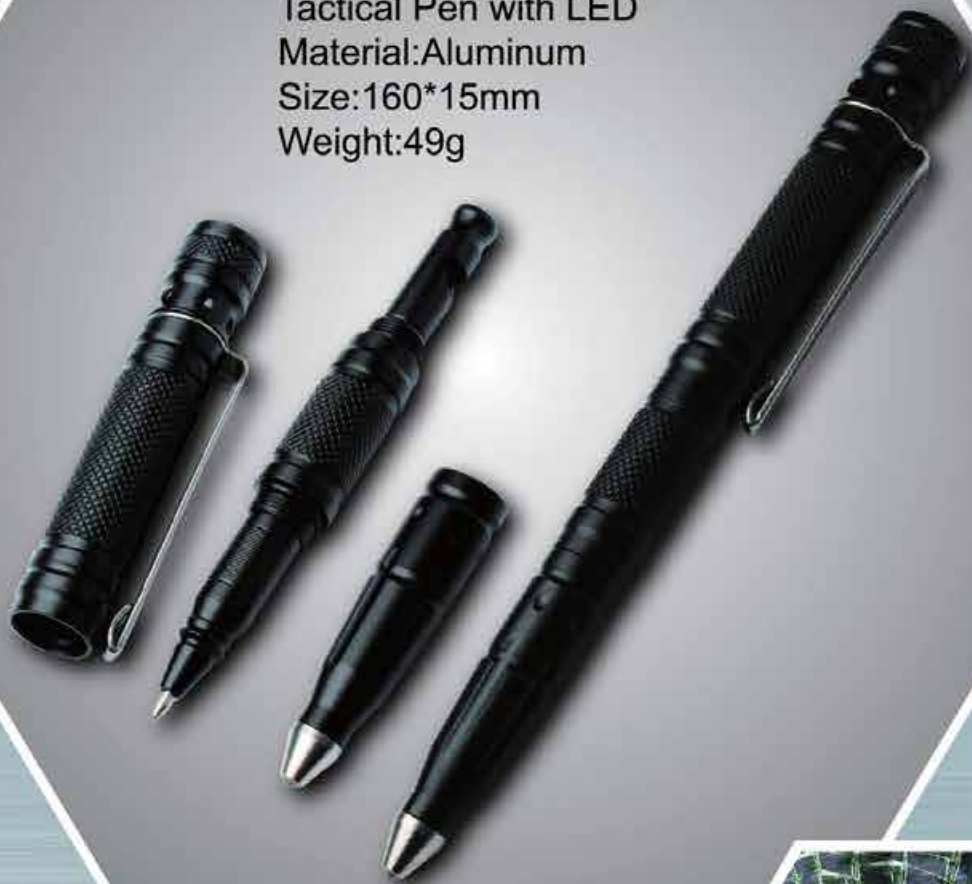

LED headlamp



Press for 3 seconds
Distress signal
Begin to shine



Glass Breaker



Knob switch

Knob switch



LED headlamp



Gift box



Extra pen refill



ONE

Survival Knife

HENSTRONG

HENSTRONG INDUSTRIAL & TRADING CO.,LTD

H-K2490270

Blade:Stainless Steel 420
Handle:G10
Closed: 113mm
Open: 200mm
Weight: 129g
Style:Folding knife with liner lock
Features: LED,Belt Cutter,USB charge

Structure Patent Belongs to Henstrong



H-K2490270-1

Blade:Stainless Steel 420
Handle:G10
Closed: 113mm
Open: 200mm
Weight: 129g
Style:Folding knife with liner lock
Features: LED,USB charge

Structure Patent Belongs to Henstrong



H-K2010024

Blade: Stainless Steel 420
Handle: Plastic
Closed: 108mm
Open: 180mm
Weight: 118g
Style: Folding knife with frame lock
Features:Flashlight,Whistle,Glass Breaker



H-K2490274

Blade:Stainless Steel(420)
Handle:Plastic
Closed:106mm
Open:180 mm
Weight:115g
Style: Folding knife with frame lock
Features:Flashlight,Whistle,Glass Breake



H-K2010038

Blade:Stainless Steel 420
Handle:Aluminum
Closed: 122mm
Open: 216mm
Weight:137g
Style: Folding knife with liner lock
Features: LED



H-K201486

Blade:Stainless Steel 420
Handle:Aluminum
Closed: 127mm
Open: 215mm
Weight: 156g
Style: Folding knife with liner lock
Features: LED, Fire Starter,Belt cutter,
Glass breaker and Bottle opener.



H-K201334

H-K201334
Blade:Stainless Steel 420
Handle:Aluminum
Closed: 120mm
Open: 210mm
Weight: 165g
Style: Folding knife with liner lock
Features: LED,Belt cutter,
Glass breaker and Bottle opener.



H-K2110124

Blade:Stainless Steel 420
Handle:Aluminum with Camo coated
Closed:122mm
Open:206mm
Weight:159g
Style:Folding knife with liner lock



H-K2010235

Blade:Stainless Steel 420
Handle:Aluminum
Closed:125mm
Open:215mm
Weight:150g
Style:Folding knife with liner lock



H-K222594

Blade:Stainless Steel 420
Handle:Aluminum
Closed:120mm
Open:205mm
Weight:128g
Style:Folding knife with liner lock



H-K2110122

Blade:Stainless Steel 420
Handle:Aluminum
Closed:134mm
Open:229mm
Weight:134g
Style:Folding knife with liner lock



H-K2110123

Blade:Stainless Steel 420
Handle:Aluminum
Closed:135mm
Open:228mm
Weight:184g
Style:Folding knife with liner lock



H-K201550

Blade:Stainless Steel 420
Handle:Aluminum
Closed: 129mm
Open:216mm
Weight: 129g
Style:Folding knife with liner lock



H-K2110120

Blade:Stainless Steel 420
Handle:Aluminum
Closed:125mm
Open:212mm
Weight:146g
Style:Folding knife with liner lock



H-K201253

Blade:Stainless Steel 420
Handle:Aluminum
Closed:135mm
Open:230mm
Weight: 170g
Style:Folding knife with liner lock



H-K201352

Blade:Stainless Steel 420
Handle:Aluminum
Closed:120mm
Open:205mm
Weight:135g
Style:Folding knife with liner lock



Survival Knife

H-K219858

Blade:Stainless Steel 420
Handle:Aluminum
Closed:101mm
Open:168mm
Weight:111g
Style:Folding knife with liner lock



H-K229869

Blade:Stainless Steel 420
Handle:Stainless Steel 420
Closed:133mm
Open:228mm
Weight:239g
Style:Folding knife with liner lock



H-K201242A

Blade:Stainless Steel 420
Handle:Aluminum
Closed:125mm
Open:205mm
Weight:145g
Style:Folding knife with liner lock



H-K201161

Blade:Stainless Steel 420
Handle:Aluminum
Closed:125mm
Open:210mm
Weight:125g
Style:Folding knife with liner lock



H-K201244

Blade:Stainless Steel 420
Handle: Aluminum
Closed: 120mm
Open: 200mm
Weight: 140g
Style:Folding knife with liner lock



H-K2270027

Blade:Stainless Steel 420
Handle:Aluminum
Closed:115mm
Open:200mm
Weight:125g
Style:Folding knife with liner lock



H-K2010037

Blade:Stainless Steel 420
Handle:Aluminum
Closed:120mm
Open:210mm
Weight:140g
Style:Folding knife with liner lock



H-K2290066

Blade:Stainless Steel 420
Handle:Stainless Steel 420
Closed:125mm
Open:208mm
Weight:219g
Style:Folding knife with Frame lock



Survival Knife

H-K2010240

Blade:Stainless Steel 420
Handle:Stainless Steel 420
Closed:126mm
Open:218mm
Weight:163g
Style:Folding knife with liner lock



H-K2010229

Blade:Stainless Steel 420
Handle:Stainless Steel 420
with wood inlay
Closed:122mm
Open:210mm
Weight:197g
Style:Folding knife with liner lock



H-K2010237

Blade:Stainless Steel 420
Handle:Stainless steel
with Resin inlay
Closed:125mm
Open:207mm
Weight:206g
Style:Folding knife with liner lock



H-K2010238

Blade:Stainless Steel 420
Handle:Stainless Steel 420
with G10 inlay
Closed:125mm
Open:213mm
Weight:218g
Style:Folding knife with liner lock



H-K201247

Blade:Stainless Steel 420
Handle:Aluminum
Closed:120mm
Open:205mm
Weight:140g
Style:Folding knife with liner lock



H-K2430202

Blade:Stainless Steel 420
Handle:Stainless Steel 420
Closed:120mm
Open:205mm
Weight:143g
Style:Folding knife with liner lock



H-K211062

Blade:Stainless Steel 420
Handle:Stainless Steel 420
Closed: 115mm
Open: 180mm
Weight: 116g
Style:Folding knife with liner lock



H-K2110129

Blade:Stainless Steel 420
Handle:Aluminum
Closed:140mm
Open: 208mm
Weight:175g
Style:Folding knife with liner lock



Survival Knife

H-K2010231

Blade:Stainless Steel 420
Handle:Aluminum
Closed:125mm
Open:218mm
Weight:218g
Style:Folding knife with liner lock



H-K2010042

Blade:Stainless Steel 420
Handle:Aluminum
Closed:119mm
Open:201mm
Weight:148g
Style:Folding knife with liner lock



H-K2370194

Blade:Stainless Steel 420
Handle:Stainless Steel 420 with G10 inlay
Closed: 125mm
Open : 210mm
Weight:188g
Style:Folding knife with liner lock



H-K201246

Blade:Stainless Steel 420
Handle:Aluminum
Closed: 125mm
Open : 210mm
Weight:158g
Style:Folding knife with liner lock





TWO >>>>
Outdoor Knife

HENSTRONG

HENSTRONG INDUSTRIAL & TRADING CO.,LTD

H-K2010232

Blade:Stainless Steel 420
Handle:Stainless Steel 420
Closed:123mm
Open:215mm
Weight:203g
Style:Folding knife with liner lock



H-K2010222

Blade:Stainless Steel 420
Handle:Stainless Steel 420
Closed:120mm
Open:214mm
Weight:205g
Style:Folding knife with liner lock



H-K2010017

Blade:Stainless Steel 420
Handle:Stainless Steel 420
Closed:95mm
Open:167mm
Weight:109g
Style:Folding knife with liner lock



H-K2010234

Blade:Stainless Steel 420
Handle:Stainless Steel 420
Closed:120mm
Open:212mm
Weight:184g
Style:Folding knife with liner lock



H-K211063

Blade:Stainless Steel 420
Handle:Stainless Steel 420
Closed:120mm
Open: 212mm
Weight:180g
Style:Folding knife with liner lock

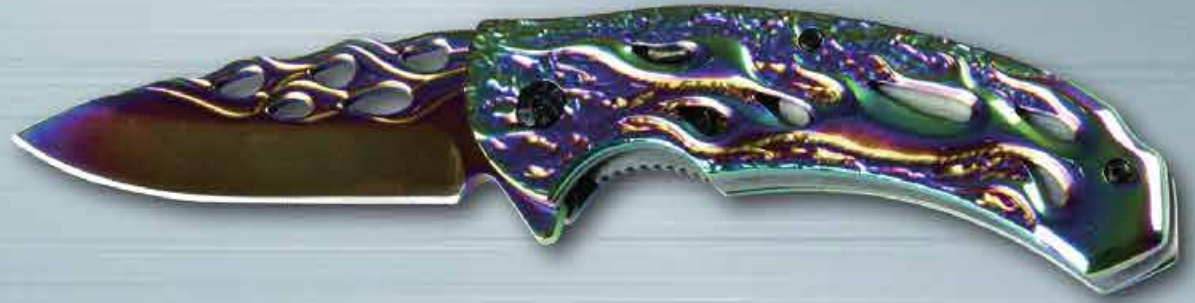

H-K201289

Blade:Stainless Steel 420
Handle:Stainless Steel 420
Closed:128mm
Open:218mm
Weight:210g
Style:Folding knife with liner lock



H-K201166

Blade:Stainless Steel 420
Handle:Stainless Steel 420
Closed:128mm
Open:225mm
Weight: 260g
Style:Folding knife with Frame lock



H-K2010241

Blade:Stainless Steel 420
Handle:Stainless Steel 420
Closed:123mm
Open:213mm
Weight:232g
Style:Folding knife with liner lock



H-K2110207

Blade:Stainless Steel 420
Handle:Stainless Steel 420
Closed:110mm
Open:210mm
Weight:146g
Style:Folding knife with liner lock



H-K2010228

Blade:Stainless Steel 420
Handle:Stainless Steel 420
Closed:117mm
Open:200mm
Weight:201g
Style:Folding knife with liner lock



H-K2010031

Blade:Stainless Steel 420
Handle:Stainless steel 420
Closed:115mm
Open:203mm
Weight:200g
Style:Folding knife with liner lock



H-K2430192

Blade:Stainless Steel 420
Handle:Stainless Steel 420
Closed:140mm
Open: 240mm
Weight:286g
Style:Folding knife with liner lock



H-K2430198

Blade:Stainless Steel 420
Handle:Stainless Steel 420
Closed:122mm
Open:211mm
Weight:196g
Style:Folding knife with liner lock



H-K2430198A

Blade:Stainless Steel 420
Handle:Stainless Steel 420
Closed:122mm
Open:211mm
Weight:202g
Style:Folding knife with liner lock



H-K2010040

Blade:Stainless Steel 420
Handle:Stainless Steel 420
Closed:123mm
Open:214mm
Weight:232g
Style:Folding knife with liner lock



H-K2290099

Blade:Stainless Steel 420
Handle:Stainless Steel 420
Closed:115mm
Open:200mm
Weight:181g
Style:Folding knife with liner lock



H-K201923

Blade:Stainless Steel 420
Handle:Stainless Steel 420
Closed:122mm
Open:215mm
Weight:246g
Style:Folding knife with liner lock



H-K229871

Blade:Stainless Steel 420
Handle:Stainless Steel 420
Closed:129mm
Open:224mm
Weight:234g
Style:Folding knife with liner lock



H-K229875

Blade:Stainless Steel 420
Handle:Stainless Steel 420
Closed:127mm
Open:222mm
Weight:225g
Style:Folding knife with liner lock



H-K229872

Blade:Stainless Steel 420
Handle:Stainless Steel 420
Closed:127mm
Open:222mm
Weight:238g
Style:Folding knife with liner lock



H-K201944

Blade:Stainless Steel 420
Handle:Stainless Steel 420
Closed:128mm
Open:227mm
Weight:201g
Style:Folding knife with liner lock



H-K229868

Blade:Stainless Steel 420
Handle:Stainless Steel 420
Closed:127mm
Open 224mm
Weight: 215g
Style:Folding knife with liner lock



H-K201924B

Blade:Stainless Steel 420
Handle:G10
Close:120mm
Open:215mm
Weight:133g
Style:Folding knife with liner lock



H-K222599

Blade:Stainless Steel 420
Handle:Aluminum
Closed:121mm
Open:210mm
Weight:135g
Style:Folding knife with liner lock



H-K201905

Blade:Stainless Steel 420
Handle:Stainless Steel 420
Closed:121mm
Open:214mm
Weight:217g
Style:Folding knife with liner lock



H-K201903

Blade:Stainless Steel 420
Handle:Stainless Steel 420
Closed:116mm
Open: 202mm
Weight: 174g
Style:Folding knife with liner lock



H-K201906

Blade:Stainless Steel 420
Handle:Stainless Steel 420
Closed:116mm
Open:202mm
Weight:187g
Style:Folding knife with liner lock



H-K2370187

Blade:Stainless Steel 420
Handle:Stainless Steel 420
Closed: 120mm
Open: 210mm
Weight: 210g
Style:Folding knife with liner lock



H-K229870-1

Blade:Stainless Steel 420
Handle:Stainless Steel 420
Closed:116mm
Open:203mm
Weight:138g
Style:Folding knife with liner lock



H-K2010233

Blade:Stainless Steel 420
Handle:Stainless Steel 420
Closed:120mm
Open:210mm
Weight:158g
Style:Folding knife with liner lock



H-K2270261

Blade:Stainless Steel 420
Handle:Stainless Steel 420
Closed:115mm
Open:195mm
Weight:106g
Style: Folding knife with frame lock



H-K2010168

Blade:Stainless Steel 420
Handle:Stainless Steel 420
Closed: 104mm
Open:180mm
Weight:102g
Style: Folding knife with frame lock



H-K2270214

Blade:Stainless Steel 420
Handle:Stainless Steel 420
Closed:90mm
Open:158mm
Weight:72g
Style:Folding knife with frame lock



H-K2010221

Blade:Stainless Steel 420
Handle:Stainless Steel 420
Closed:90mm
Open:150mm
Weight:74g
Style:Folding knife with frame lock



H-K2270255

Blade:Stainless Steel 420
Handle:Stainless Steel 420
Closed:95mm
Open:162mm
Weight:72g
Style:Folding knife with frame lock



H-K2270219

Blade:Stainless Steel 420
Handle:Stainless Steel 420
Closed:95mm
Open:160mm
Weight:80g
Style:Folding knife



H-K2270220

Blade:Stainless Steel 420
Handle:Stainless Steel 420
Closed:90mm
Open:160mm
Weight:75g
Style:Folding knife



H-K2270211

Blade:Stainless Steel 420
Handle:Stainless Steel 420
Closed:92mm
Open:164mm
Weight:71g
Style:Folding knife with liner lock



H-K219688

Blade:Stainless Steel 420
Handle:Stainless Steel 420
Closed: 101mm
Open:173mm
Weight:140g
Style:Folding knife with liner lock



H-K219682

Blade:Stainless Steel 420
Handle:Stainless Steel 420
Closed:101mm
Open:182mm
Weight:114g
Style:Folding knife with frame lock



H-K2290101

Blade:Stainless Steel 420
Handle:Stainless Steel 420
Closed:122mm
Open:213mm
Weight:209g
Style:Folding knife with liner lock



H-K219619

Blade:Stainless Steel 420
Handle:Stainless Steel 420
Closed:113mm
Open:194mm
Weight:124g
Style:Folding knife with liner lock



H-K201266

Blade:Stainless Steel 420
Handle:Aluminum
Closed:113mm
Open:190mm
Weight:120g
Style:Folding knife with liner lock



H-K2370180

Blade:Stainless Steel 420
Handle:Aluminum
Closed:128mm
Open: 215mm
Weight:126g
Style:Folding knife with liner lock



H-K2430190

Blade:Stainless Steel 420
Handle:Stainless Steel 420
Closed:120mm
Open:207mm
Weight:136g
Style:Folding knife with frame lock



H-K201187

Blade:Stainless Steel 420
Handle:Stainless Steel 420
Closed: 80mm
Open:145mm
Weight:50g
Style:Folding knife with Liner lock



H-K201361

Blade:Stainless Steel 420
Handle:Stainless Steel 420
Closed:95mm
Open:165mm
Weight:80g
Style:Folding knife with Liner lock



H-K227731

Blade:Stainless Steel 420
Handle:Stainless Steel 420
Closed:97mm
Open: 169mm
Weight:83g
Style:Folding knife with frame lock



H-K220851

Blade:Stainless Steel 420
Handle:Aluminum
Closed:90mm
Open:150mm
Weight:61g
Style:Folding knife with liner lock



H-K2370195

Blade:Stainless Steel 420
Handle:Aluminum
Closed :110mm
Open: 192mm
Weight: 102g
Style:Folding knife with liner lock



H-K2270262

Blade:Stainless Steel 420
Handle:Stainless Steel 420
Closed :115mm
Open:200mm
Weight:116g
Style:Folding knife with liner lock



H-K2010227

Blade:Stainless Steel 420
Handle:Stainless Steel 420
Closed:125mm
Open:215mm
Weight:206g
Style:Folding knife with liner lock



H-K219677

Blade:Stainless Steel 420
Handle:Aluminum
Closed: 115mm
Open: 199mm
Weight: 130g
Style:Folding knife with liner lock



H-K2370193

Blade: Stainless Steel 420
Handle: Aluminum
Closed: 120mm
Open: 210mm
Weight:157g
Style:Folding knife with liner lock



H-K2110128

Blade:Stainless Steel 420
Handle:Aluminum
Closed:130mm
Open: 187mm
Weight:123g
Style:Folding knife with liner lock



H-K2110127

Blade:Stainless Steel 420
Handle:Aluminum
closed:135mm
Open:194mm
Weight:150g
Style:Folding knife with liner lock



H-K2110188

Blade:Stainless Steel 420
Handle:Aluminum
Closed:121mm
Open:190mm
Weight:110g
Style:Folding knife with liner lock



H-K2370191

Blade:Stainless Steel 420
Handle:Aluminum with G10 inlay
Closed: 113mm
Open: 170mm
Weight:93g
Style:Folding knife with liner lock



H-K2370184

Blade:Stainless Steel 420
Handle:G10
Closed: 118mm
Open:205mm
Weight: 138g
Style:Folding knife with liner lock



H-K201341

Blade:Stainless Steel 420
Handle:Aluminum
Closed: 125mm
Open: 210mm
Weight: 125g
Style:Folding knife with liner lock



H-K201342

Blade:Stainless Steel 420
Handle:Aluminum
Closed: 125mm
Open: 210mm
Weight: 130g
Style:Folding knife with liner lock



H1179

Blade:Stainless Steel 420
Handle:Aluminum
Closed: 115mm
Open:90mm
Weight: 120g
Style:Folding knife with liner lock



H-K219675

Blade:Stainless Steel 420
Handle:Aluminum
Closed: 115mm
Open:196mm
Weight: 134g
Style:Folding knife with liner lock



H-K201207

Blade:Stainless Steel 420
Handle:Aluminum
Closed : 125mm
Open: 210mm
Weight: 180g
Style:Folding knife with liner lock



H-K2010053

Blade:Stainless Steel 420
Handle:Aluminum
Closed: 121mm
Open: 215mm
Weight:153g
Style:Folding knife with liner lock



H-K2110247

Blade:Stainless Steel 420
Handle:G10
Closed: 116mm
Open:195mm
Weight: 122g
Style:Folding knife with liner lock

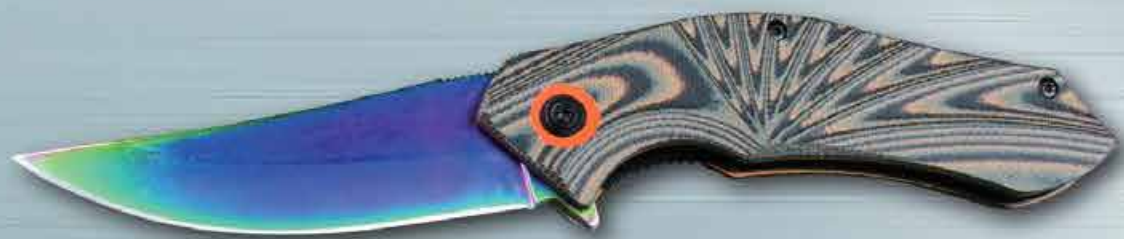

H-K2110248

Blade:Stainless Steel 420
Handle:G10
Closed: 116mm
Open:195mm
Weight: 122g
Style:Folding knife with liner lock



H-K2110249

Blade:Stainless Steel 420
Handle:G10
Closed: 116mm
Open:195mm
Weight: 122g
Style:Folding knife with liner lock



H-K2010039

Blade:Stainless Steel 420
Handle:G10
Closed: 121mm
Open: 211mm
Weight:138g
Style:Folding knife with liner lock



H-K2430204

Blade:Stainless Steel 420
Handle:Aluminum
Closed:130mm
Open:220mm
Weight:100g
Style:Folding knife with liner lock



H-K2430191

Blade:Stainless Steel 420
Handle:Stainless Steel with G10
Closed:120mm
Open:222mm
Weight:153g
Style:Folding knife with liner lock



H-K2430191A

Blade:Stainless Steel 420
Handle:Stainless Steel with G10
Closed:120mm
Open:222mm
Weight:153g
Style:Folding knife with liner lock



H-K2490273

Blade:Stainless Steel 420
Handle:Aluminum
Closed:115mm
Open:202mm
Weight:125g
Style:Folding knife with liner lock



H-K222590

Blade:Stainless Steel 420
Handle:Aluminum
Closed: 117mm
Overall: 202mm
Weight:133g
Style:Folding knife with liner lock



H-K2270030

Blade:Stainless Steel 420
Handle:Aluminum
Closed:116mm
Open:200mm
Weight:120g
Style:Folding knife with liner lock



H-K211937

Blade:Stainless Steel 420
Handle:Aluminum
Closed:130mm
Open:220mm
Weight:165g
Style:Folding knife with liner lock



H-K2300062

Blade:Stainless Steel 420
Handle:Aluminum
Closed:113mm
Open:192mm
Weight:112g
Style:Folding knife with liner lock



H-K2010236

Blade:Stainless Steel 420
Handle:Aluminum
Closed:122mm
Open:205mm
Weight:153g
Style:Folding knife with liner lock



H-K2010230

Blade:Stainless Steel 420
Handle:Aluminum
Closed:122mm
Open:218mm
Weight:150g
Style:Folding knife with liner lock



H-K2010224

Blade:Stainless Steel 420
Handle:Stainless Steel with plastic
Closed:123mm
Open:215mm
Weight:150g
Style:Folding knife with liner lock



H-K201572

Blade:Stainless Steel 420
Handle:Stainless Steel with G10
Closed:123mm
Open:204mm
Weight:214g
Style:Folding knife with liner lock



H-K2110257

Blade:Stainless Steel 420
Handle:Aluminum with Plastic
Closed:123mm
Open:212mm
Weight:220g
Style:Folding knife with liner lock



H-K219857

Blade:Stainless Steel 420
Handle:Aluminum
Closed:110mm
Open:189mm
Weight:135g
Style:Folding knife with back lock



H-K222611

Blade:Stainless Steel 420
Handle:Aluminum
Closed:125mm
Open:216mm
Weight:142g
Style:Folding knife with liner lock



H-K211941

Blade:Stainless Steel 420
Handle:Aluminum
Closed:129mm
Open:222mm
Weight:171g
Style:Folding knife with liner lock



H-K2370202

Blade:Stainless Steel 420
Handle:Aluminum
Closed:105mm
Open:183mm
Weight: 92g
Style:Folding knife with liner lock



H-K2370190

Blade:Stainless Steel 420
Handle:Aluminum
Closed:112mm
Open:200mm
Weight:103g
Style:Folding knife with liner lock



H-K2370182

Blade:Stainless Steel 420
Handle:Aluminum
Closed:115mm
Open: 198mm
Weight:126g
Style:Folding knife with liner lock



H-K2370188

Blade:Stainless Steel 420
Handle:Aluminum
Closed :105mm
Open:187mm
Weight: 100g
Style:Folding knife with liner lock



H-K2370185

Blade:Stainless Steel 420
Handle:Aluminum
Closed :115mm
Open:195mm
Weight: 138g
Style:Folding knife with liner lock



H-K2110187

Blade:Stainless Steel 420
Handle:Aluminum
Closed:127mm
Open:217mm
Weight:167g
Style:Folding knife with liner lock



H-K2010050

Blade:Stainless Steel 420
Handle:Aluminum
Closed:123mm
Open:208mm
Weight:145g
Style:Folding knife with liner lock



H-K2010102

Blade:Stainless Steel 420
Handle:Aluminum
Closed:123mm
Open: 215mm
Weight:149g
Style:Folding knife with liner lock



H-K201667

Blade:Stainless Steel 420
Handle:Aluminum
Closed:102mm
Open:182mm
Weight:106g
Style:Folding knife with liner lock



H-K211554

Blade:Stainless Steel 420
Handle:Aluminum
Closed:116mm
Open:213mm
Weight:128g
Style:Folding knife with liner lock



H-K2270106

Blade:Stainless Steel 420
Handle:Aluminum
Closed: 115mm
Open: 203mm
Weight:118g
Style:Folding knife with liner lock



H-K222598

Blade:Stainless Steel 420
Handle:Aluminum
Closed:113mm
Open:199mm
Weight:123g
Style:Folding knife with liner lock



H-K2110189

Blade:Stainless Steel 420
Handle:Aluminum
Closed:133mm
Open:225mm
Weight:167g
Style:Folding knife with liner lock



H-K2110016

Blade:Stainless Steel 420
Handle:Aluminum
Closed:122mm
Open:212mm
Weight:142g
Style:Folding knife with liner lock



H-K201920

Blade:Stainless Steel 420
Handle:Stainless Steel 420
Closed:122mm
Open:214mm
Weight:133g
Style:Folding knife with liner lock



H-K227028

Blade:Stainless Steel 420
Handle:Aluminum
Closed:115mm
Open:200mm
Weight:127g
Style:Folding knife with liner lock



H-K2010046

Blade:Stainless Steel 420
Handle:Aluminum
Closed: 112mm
Open: 198mm
Weight:118g
Style:Folding knife with liner lock



H-K222592

Blade:Stainless Steel 420
Handle:Aluminum
Closed:120mm
Open:204mm
Weight:114g
Style:Folding knife with liner lock



H-K222613

Blade:Stainless Steel 420
Handle:Aluminum
Closed:127mm
Open:219mm
Weight:157g
Style:Folding knife with liner lock



H-K222606

Blade:Stainless Steel 420
Handle:Aluminum
Closed:119mm
Open:203mm
Weight:148g
Style:Folding knife with liner lock



H-K2010049

Blade:Stainless Steel 420
Handle:Aluminum
Closed:127mm
Open:214mm
Weight:144g
Style:Folding knife with liner lock



H-K227026

Blade:Stainless Steel 420
Handle:Aluminum
Closed: 115mm
Open: 190mm
Weight:171g
Style:Folding knife with liner lock



H-K2300058

Blade:Stainless Steel 420
Handle:Aluminum
Closed:99mm
Open:166mm
Weight:80g
Style:Folding knife with liner lock



H-K2300061

Blade:Stainless Steel 420
Handle:Aluminum
Closed:114mm
Open:196mm
Weight:100g
Style:Folding knife with liner lock



H-K2300061-1

Blade:Stainless Steel 420
Handle:Aluminum
Closed:81mm
Open:134mm
Weight:42g
Style:Folding knife with liner lock



H-K222608

Blade:Stainless Steel 420
Handle:Aluminum
Closed:122mm
Open:215mm
Weight:142g
Style:Folding knife with liner lock



H-K222610

Blade:Stainless Steel 420
Handle:Aluminum
Closed:126mm
Open:220mm
Weight:149g
Style:Folding knife with liner lock



H-K222612

Blade:Stainless Steel 420
Handle:Aluminum
Closed:123mm
Open: 222mm
Weight:144g
Style:Folding knife with liner lock



H-K222589A

Blade:Stainless Steel 420
Handle:Aluminum
Closed:102mm
Open:176mm
Weight:94g
Style:Folding knife with liner lock



H-K222589

Blade:Stainless Steel 420
Handle:Aluminum With
Camo coated
Closed:102mm
Open:176mm
Weight:94g
Style:Folding knife with liner lock



H-K2430194

Blade:Stainless Steel 420
Handle:Plastic with
camo coated
Closed:115mm
Open:217mm
Weight:126g
Style:Folding knife with liner lock



H-K222586

Blade:Stainless Steel 420
Handle:Aluminum
with camo coated
Closed:93mm
Open:150mm
Weight:82g
Style:Folding knife with liner lock



H-K222666

Blade:Stainless Steel 420
Handle:Stainless steel 420
with Camo Coated
Closed:120mm
Open:210mm
Weight:211g
Style:Folding knife with liner lock



H-K2010034

Blade:Stainless Steel 420
Handle:Aluminum
Closed:115mm
Open:198mm
Style:Folding knife with liner lock



H-K201236

Blade:Stainless Steel 420
Handle:Stainless Steel420
Closed:117mm
Open:205mm
Weight:200g
Style:Folding knife with liner lock



H-K227743

Blade:Stainless Steel 420
Handle:Aluminum
Closed:100mm
Open:168mm
Weight:70g
Style:Folding knife with liner lock



H-K219626

Blade:Stainless Steel 420
Handle:Stainless Steel 420
Closed:86mm
Open:146mm
Weight:64g
Style:Folding knife with Back lock



H-K222602

Blade:Stainless Steel 420
Handle:Aluminum
Closed:115mm
Open: 195mm
Weight:126g
Style:Folding knife with liner lock



H-K2270213

Blade:Stainless Steel 420
Handle:Aluminum
Closed:100mm
Open:173mm
Weight:96g
Style:Folding knife with liner lock



H-K2270209

Blade:Stainless Steel 420
Handle:Aluminum
Closed:95mm
Open:162mm
Weight:91g
Style:Folding knife with liner lock



H-K2270263

Blade:Stainless Steel 420
Handle:Plastic
Closed:95mm
Open:165mm
Weight:91g
Style:Folding knife with liner lock



H-K2270264

H-K2270264
Blade:Stainless Steel 420
Handle:Plastic
Closed:95mm
Open:165mm
Weight:93g
Style:Folding knife with liner lock



H-K2430193

H-K2430193
Blade:Stainless Steel 420
Handle:Aluminum
Closed:115mm
Open:197mm
Weight:116g
Style:Folding knife with liner lock



H-K2270210

Blade:Stainless Steel 420
Handle:Stainless Steel with Aluminum inlay
Closed:95mm
Open:162mm
Weight:79g
Style:Folding knife with liner lock



H-K205180

Blade:Stainless Steel 420
Handle:Aluminum
Closed:105mm
Open:180mm
Weight:70g
Style:Folding knife with liner lock



H-K2270258

Blade:Stainless Steel 420
Handle:G10
Closed: 90mm
Open:148mm
Weight:41.5g
Style:Folding knife with frame lock



H-K201272

Blade:Stainless Steel 420
Handle:Stainless Steel 420
Closed:115mm
Open:190mm
Weight:120g
Style:Folding knife with frame lock



H-K220848

Blade:Stainless Steel 420
Handle:Aluminum
Closed:98mm
Open:170mm
Weight:68g
Style:Folding knife with frame lock



H-K201985

Blade:Stainless Steel 420
Handle:Stainless Steel 420
Closed:119mm
Open:203mm
Weight:154g
Style:Folding knife with frame lock



H-K203154

Blade:Stainless Steel 420
Handle:Stainless Steel 420
Closed:105mm
Open:170mm
Weight:60g
Style:Folding knife with frame lock



H-K227741

Blade:Stainless Steel 420
Handle:Stainless Steel 420 With Camo Coated
Closed:116mm
Open:199mm
Weight:113g
Style:Folding knife with frame lock



H-K227737

Blade:Stainless Steel 420
Handle:Stainless Steel 420
Closed:95mm
Open:164mm
Weight:74g
Style:Folding knife with Liner lock



H-K226725

BBlade:Stainless Steel 420
Handle:Stainless Steel 420
Closed:114mm
Open:198mm
Weight:103g
Style:Folding knife with Liner lock



H-K2370201

Blade:Stainless Steel 420
Handle:Aluminum
Closed:95mm
Open:170mm
Weight: 75g
Style:Folding knife with liner lock



H-K2370189

Blade:Stainless Steel 420
Handle:Aluminum with Plastic
Closed:115mm
Open:203mm
Weight:120g
Style:Folding knife with liner lock



H-K2370181

Blade:Stainless Steel 420
Handle:G10
Closed:120mm
Open : 213mm
Weight:138g
Style:Folding knife with liner lock



H-K2010242

Blade:Stainless Steel 420
Handle:Stainless steel 420 with G10 inlay
Closed:127mm
Open:217mm
Weight:211g
Style:Folding knife with liner lock



H-K2110243A

Blade:Stainless Steel 420
Handle:Stainless steel with G10 inlay
Closed:127mm
Open:217mm
Weight:211g
Style:Folding knife with liner lock



H-K2110250

Blade:Stainless Steel 420
Handle:G10
Closed:110mm
Open:195mm
Weight:107g
Style:Folding knife with liner lock



H-K2370196

Blade:Stainless Steel 420
Handle:Camo coated
Closed:115mm
Open: 200mm
Weight:121g
Style:Folding knife with liner lock



H-K2370199

Blade:Stainless Steel 420
Handle:Stainless Steel 420 with G10
Closed:103mm
Open: 175mm
Weight:107g
Style:Folding knife with liner lock



H-K2370203

Blade:Stainless Steel 420
Handle:Stainless Steel 420 with G10
Closed:112mm
Open: 195mm
Weight:117g
Style:Folding knife with liner lock



H-K2370204

Blade:Stainless Steel 420
Handle:Stainless Steel 420 with G10
Closed: 125mm
Open:225mm
Weight:192g
Style:Folding knife with liner lock



H-K2370183

Blade:Stainless Steel 420
Handle:Stainless Steel 420 with G10
Closed:112mm
Open: 198mm
Weight:141g
Style:Folding knife with liner lock



H-K2370192

Blade:Stainless Steel 420
Handle:Stainless Steel 420 with Wood
Closed : 89mm
Open:150mm
Weight:106g
Style:Folding knife with liner lock



H-K2370200

Blade:Stainless Steel 420
Handle:Stainless Steel 420 with Wood
Closed: 98mm
Open: 170mm
Weight:110g
Style:Folding knife with liner lock



H-K2270212

Blade:Stainless Steel 420
Handle:Stainless Steel 420 with G10
Closed:98mm
Open:168mm
Weight:86g
Style:Folding knife with liner lock



H-K201210

Blade:Stainless Steel 420
Handle:Aluminum
Closed:120mm
Open:205mm
Weight: 145g
Style:Automatic Folding knife



H-K201975

Blade:Stainless Steel 420
Handle:G10
Closed:114mm
Open:199mm
Weight:128g
Style:Folding knife with liner lock



H-K201979

Blade:Stainless Steel 420
Handle:G10
Closed:114mm
Open:200mm
Weight:112g
Style:Folding knife with liner lock



H-K2370197

Blade:Stainless Steel 420
Handle:G10
Closed:120mm
Open: 215mm
Weight:145g
Style:Folding knife with liner lock



H-K201919

Blade:Stainless Steel 420
Handle:G10
Closed :120mm
Open: 206mm
Weight: 126g
Style:Folding knife with liner lock



H-K201885A

Blade:Stainless Steel 420
Handle:G10
Closed: 120mm
Open: 210mm
Weight: 127g
Style:Folding knife with liner lock



H-K201918

Blade:Stainless Steel 420
Handle:G10
Closed: 115mm
Open:201mm
Weight: 120g
Style:Folding knife with liner lock



H-K201969

Blade:Stainless Steel 420
Handle:G10
Closed: 113mm
Open:195mm
Weight:109g
Style:Folding knife with liner lock



H-K229877

Blade:Stainless Steel 420
Handle:G10
Closed: 127mm
Open:223mm
Weight: 158g
Style:Folding knife with liner lock



H-K229876

Blade:Stainless Steel 420
Handle:G10
Closed: 116mm
Open:207mm
Weight: 122g
Style:Folding knife with liner lock



H-K2010019

Blade:Stainless Steel 420
Handle:G10 with Stainless Steel overlay
Closed:115mm
Open:204mm
Weight:123g
Style:Folding knife with liner lock



H-K201970

Blade:Stainless Steel 420
Handle: G10
Closed: 122mm
Open: 217mm
Weight: 130g
Style:Folding knife with liner lock



H-K2490269

Blade:Stainless Steel 420
Handle:Stainless with Wood inlay
Closed:120mm
Open:210mm
Weight:281g
Style:Folding knife with Back lock



H-K227421

Blade:Stainless Steel 420
Handle:Stainless Steel 420 with wood
Closed:115mm
Open:195mm
Style:Folding knife with Frame lock



H-K2430197

Blade:Stainless Steel 420
Handle:Stainless Steel 420 with wood inlay
Closed:125mm
Open:210mm
Style:Folding knife with liner lock



H-K2430199

Blade:Stainless Steel 420
Handle:Stainless Steel 420 with wood inlay
Closed:115mm
Open:197mm
Weight:130g
Style:Folding knife with liner lock



H-K2270216

Blade:Stainless Steel 420
Handle:Stainless Steel 420 with wood inlay
Closed:128mm
Open:222mm
Weight:200g
Style:Folding knife with frame lock



H-K201275

Blade:Stainless Steel 420
Handle:Wood
Closed:97mm
Open:168mm
Weight:110g
Style:Folding knife with Liner lock



H-K2010225

Blade:Stainless Steel 420
Handle:Stainless Steel 420 with wood
Closed:113mm
Open:195mm
Weight:161g
Style:Folding knife with liner lock



H-K2270259

Blade:Stainless Steel 420
Handle:Stainless Steel 420 with wood inlay
Closed:100mm
Open:171mm
Weight:94g
Style:Folding knife with liner lock



H-K2110254

Blade:Stainless Steel 420
Handle:Wood
Closed:115mm
Open:205mm
Weight:133g
Style:Folding knife with liner lock



H-K2430195

Blade:Stainless Steel 420
Handle:Wood
Closed:116mm
Open:198mm
Weight:108g
Style:Folding knife with liner lock



H-K2270260

BBlade:Stainless Steel 420
Handle:Wood
Closed:120mm
Open:220mm
Weight:137g
Style:Folding knife with liner lock



H-K2490267

Blade:Stainless Steel 420
Handle:Wood
Closed:115mm
Open:200mm
Style:Folding knife with liner lock



H-K2490267S

Blade:Stainless Steel 420
Handle:Wood
Closed:100mm
Open:180mm
Weight:100g
Style:Folding knife with liner lock



H-K2490265

Blade:Stainless Steel 420
Handle:G10
Closed :115mm
Open:200mm
Weight:103g
Style:Folding knife with liner lock



H-K2490265S

Blade:Stainless Steel 420
Handle:G10
Closed:100mm
Open:180mm
Weight:85g
Style:Folding knife with liner lock



H-K2490266

Blade:Stainless Steel 420
Handle:G10
Closed:115mm
Open:200mm
Weight:104g
Style:Folding knife with liner lock



H-K2490266S

Blade:Stainless Steel 420
Handle:G10
Closed:100mm
Open:175mm
Weight:86g
Style:Folding knife with liner lock



H-K2110206

Blade:Stainless Steel 420
Handle:G10
Closed:128mm
Open:206mm
Weight:128g
Style:Folding knife with liner lock



H-K2110208

Blade:Stainless Steel 420
Handle:G10
Closed:127mm
Open:212mm
Weight:170g
Style:Folding knife with liner lock



H-K2270218

Blade:Stainless Steel 420
Handle:Plastic with Camo coated
Closed:115mm
Open:197mm
Weight:103g
Style:Folding knife with liner lock



H-K227748

Blade:Stainless Steel 420
Handle:Plastic with Camo coated
Closed:115mm
Open:195mm
Weight:218g
Style:Folding knife with liner lock



H-K227748-1

Blade:Stainless Steel 420
Handle:ABS
Closed:115mm
Open:195mm
Weight:216g
Style:Folding knife with liner lock



H-K227749

Blade:Stainless Steel 420
Handle:Aluminum with Plastic inlay
Closed:126mm
Open: 206mm
Weight:159g
Style:Folding knife with liner lock



H-K2010223

Blade:Stainless Steel 420
Handle:Plastic
Closed:125mm
Open:215mm
Weight:154g
Style:Folding knife with liner lock



H-K2010035

Blade:Stainless Steel 420
Handle:Plastic
Closed:116mm
Open:196mm
Weight:102g
Style:Folding knife with liner lock



H-K2430205

Blade:Stainless Steel 420
Handle:Plastic
Closed:110mm
Open:190mm
Weight:143g
Style:Folding knife with liner lock



H-K2010021

Blade:Stainless Steel 420
Handle:Plastic with rope
Closed:122mm
Open:215mm
Weight:123g
Style:Folding knife with liner lock



H-K2010226

Blade:Stainless Steel 420
Handle:Plastic
Closed:120mm
Open:216mm
Weight:148g
Style:Folding knife with liner lock



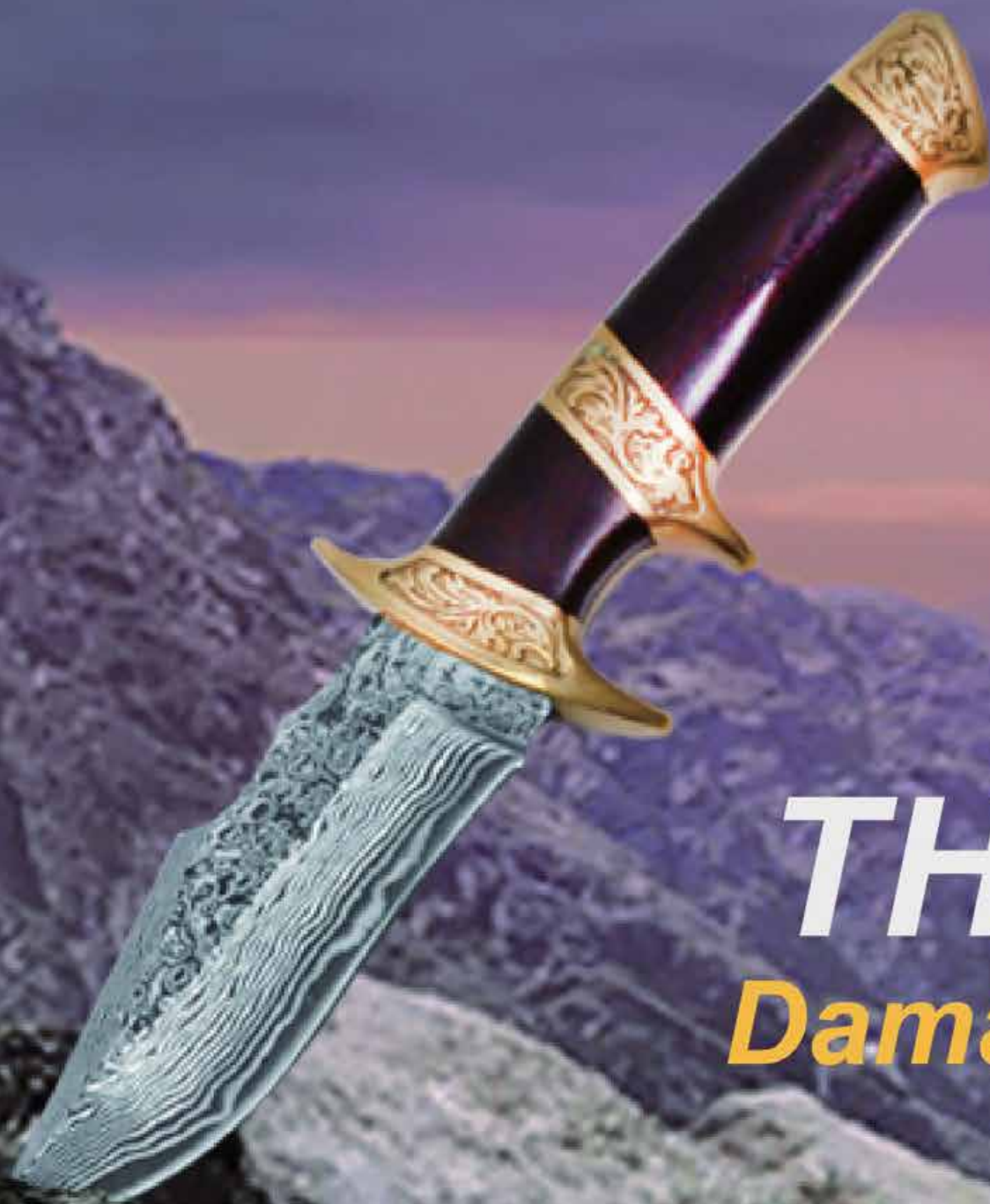

THREE

Damascus knife

HENSTRONG

HENSTRONG INDUSTRIAL & TRADING CO.,LTD

H-KD16001

Blade:Damascus steel
Handle:stainless steel 420 with Wood inlay
Closed:126mm
Open:216mm
Weight:210g
Style:Folding knife with liner lock



H-KD16002

Blade:Damascus steel
Handle:stainless steel 420 with Wood
Closed:120mm
Open:205mm
Weight:129g
Style:Folding knife with liner lock



H-KD16003

Blade:Damascus steel
Handle:G10
Closed:115mm
Open:203mm
Weight:173g
Style:Folding knife with liner lock



H-K2060074

Blade:Damascus steel
Handle:Damascus steel
Blade length:70mm
Overall:145mm
Weight:36g
Style:Fixed blade knife



Damascus Knife

H-K2060073

Blade:Damascus steel
Handle:sandalwood + cast copper
Blade length:95mm
Overall:220mm
Weight:157g
Style:Fixed blade knife



H-K2060072A

Blade:Damascus steel
Handle:sandalwood + cast copper
Blade length:95mm
Overall:205mm
Weight:228g
Style:Fixed blade knife



H-K2060070

Blade:Damascus steel
Handle:Stainless steel(2CR13) +antler
Blade length:88mm
Overall:200mm
Weight:161g
Style:Fixed blade knife



H-K2060071

Blade:Damascus steel
Handle:Stainless steel(2CR13) +rosewood
Blade length:95mm
Overall:215mm
Weight:157g
Style:Fixed blade knife





FOUR >>>>
Hunting Knife

HENSTRONG

HENSTRONG INDUSTRIAL & TRADING CO.,LTD

H-K2490268

Blade:Stainless Steel 420
Handle:Wood
Blade Length:80mm
Overall:150mm
Weight:86g
Style:Hunting knife



H-K206662

Blade:Stainless Steel 7Cr17
Handle:G10
Blade Length:130mm
Overall:245mm
Weight:277g
Style:Hunting knife



H-K206661

Blade:Stainless Steel 7Cr17
Handle:G10
Blade Length:132mm
Overall: 252mm
Weight:272g
Style:Hunting knife



H-K228763

Blade:Stainless Steel 420
Handle:Wood
Blade length:162mm
Overall:300mm
Weight:260g
Style:Hunting knife



H-K219640

Blade:Stainless Steel 2Cr13
Handle:Burl Wood
Blade Length:94mm
Overall:212mm
Style:Hunting knife



H-K201577

Blade:Stainless Steel 2Cr13
Handle:Wood
Blade Length:106mm
Overall:238mm
Style:Hunting knife



H-K206656

Blade:Stainless Steel 7Cr17/440A
Handle:G10
Blade Length:83mm
Overall:198mm
Style:Hunting knife



H-K206660

Blade:Stainless Steel 7Cr17/440A
Handle:G10
Blade Length:85mm
Overall:200mm
Style:Hunting knife





FIVE

Tactical Pen

HENSTRONG

HENSTRONG INDUSTRIAL & TRADING CO.,LTD



LED headlamp



Glass Breaker



H-O240170

Tactical Pen with LED
Material: Aluminum
Size: 156*14mm
Weight: 45g

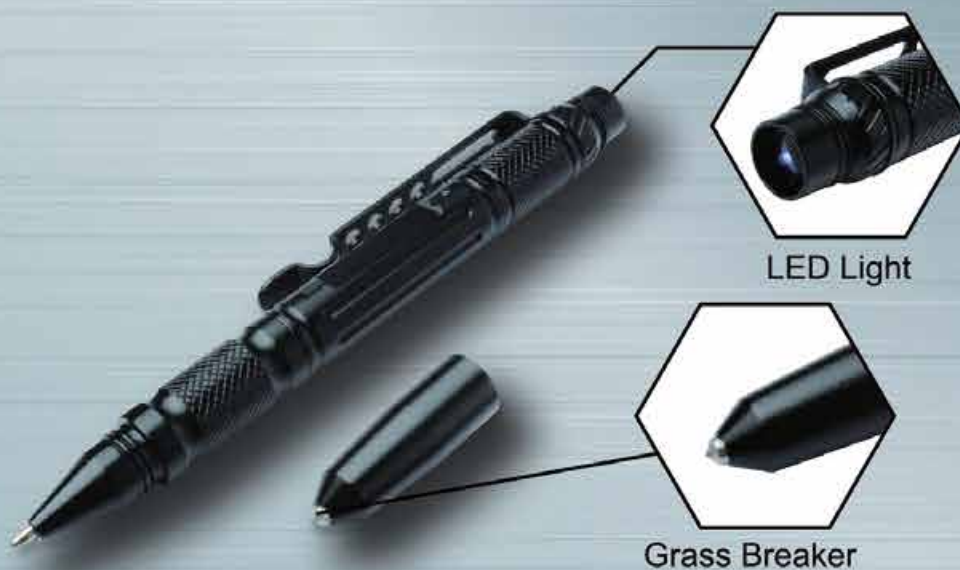

H-O240181

Tactical Pen With LED
Material: Aluminum
Size: 160*14mm
Weight: 46g

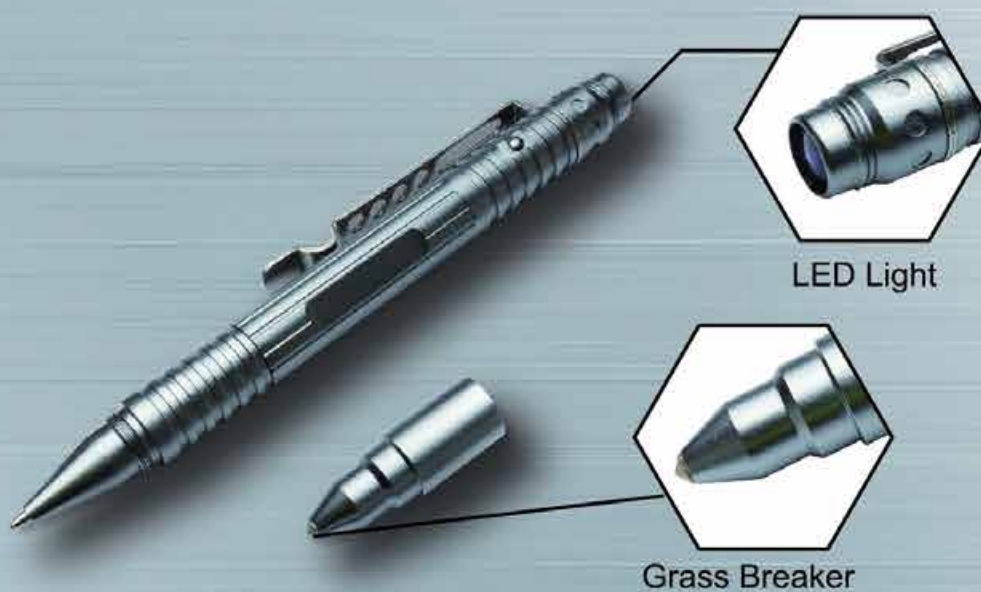

H-O240182

Tactical Pen with LED
Material: Aluminum
Size: 160*15mm
Weight: 49g

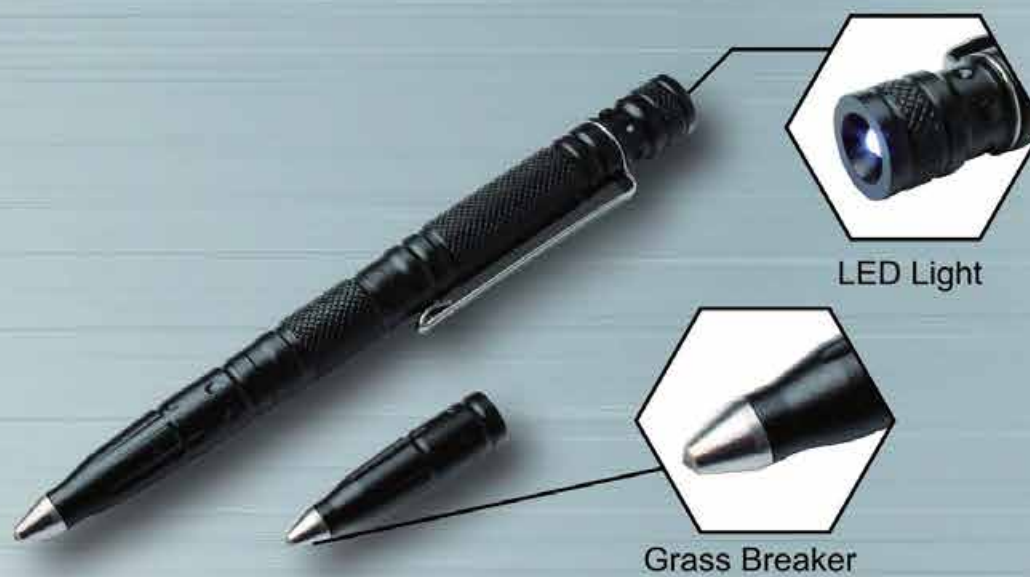

Tactical Pen

H-O240171

Tactical Pen
Material:Aluminum
Size:150*14mm
Weight:46g



H-O240172

Tactical Pen With whistle
Material:Aluminum
Size:105*11mm
Weight:46g

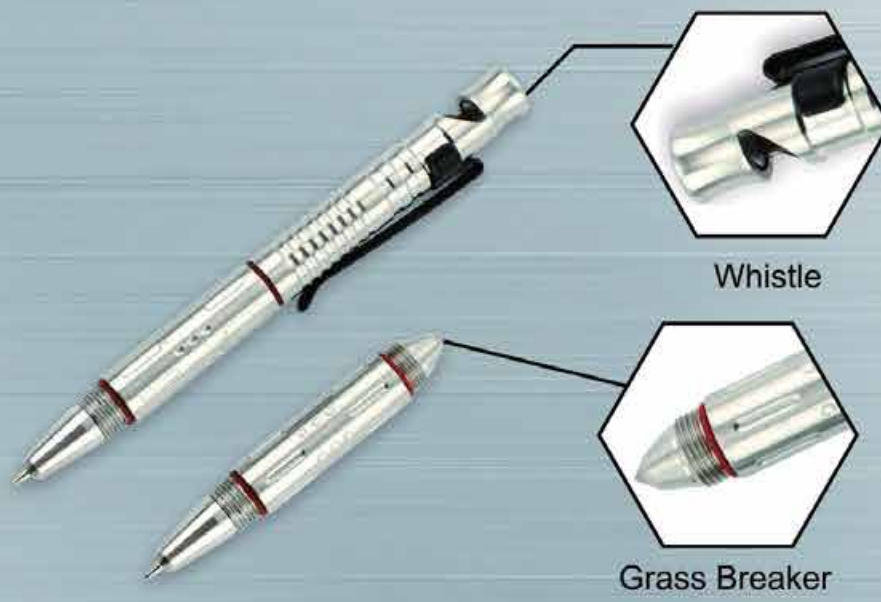

H-O240177

Tactical pen
Material: Aluminum
Sizes:155*12mm
Weight:30g

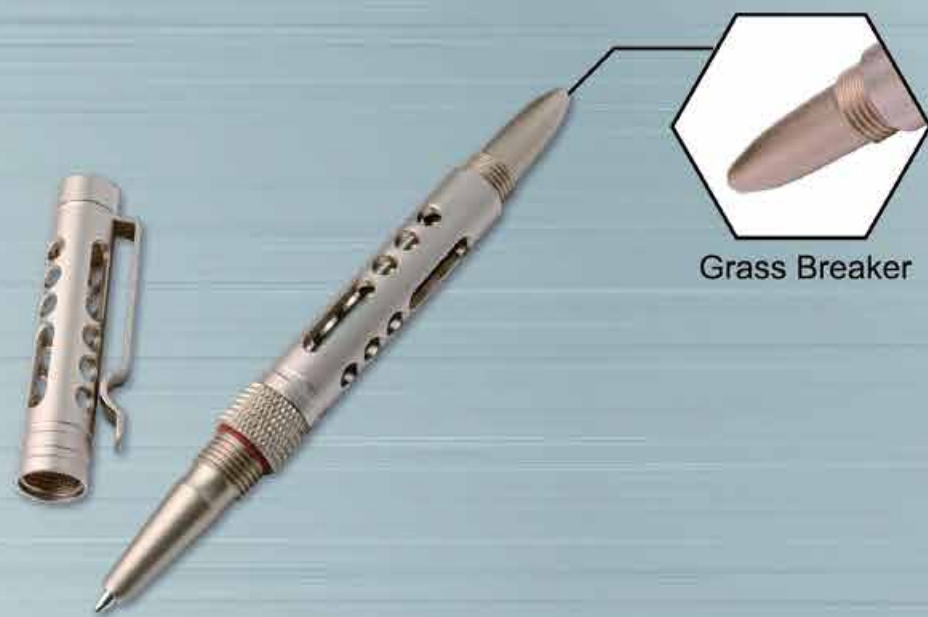

H-O240176

Tactical pen
Material: Aluminum
Sizes: 145*12mm
Weight: 30g



Grass Breaker

H-O240179

Tactical pen
Material: Aluminum
Sizes: 140*13mm
Weight: 35g



Grass Breaker

H-O240175

Tactical pen
Material: Aluminum
Sizes: 151*11mm
Weight: 64g

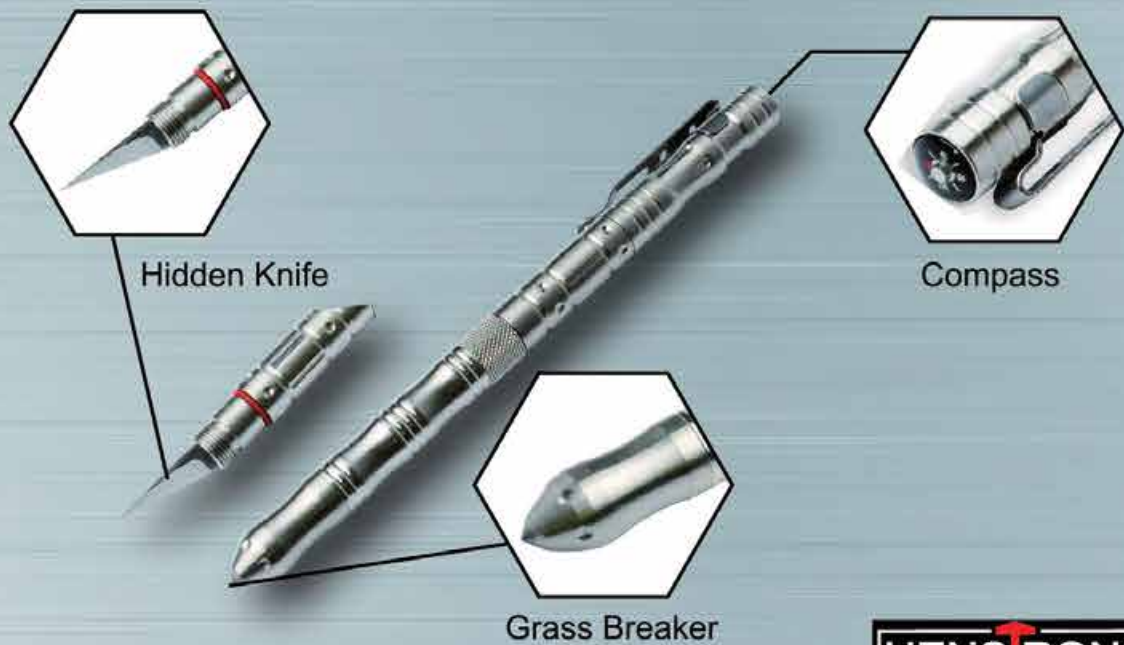

Hidden Knife

Compass

Grass Breaker

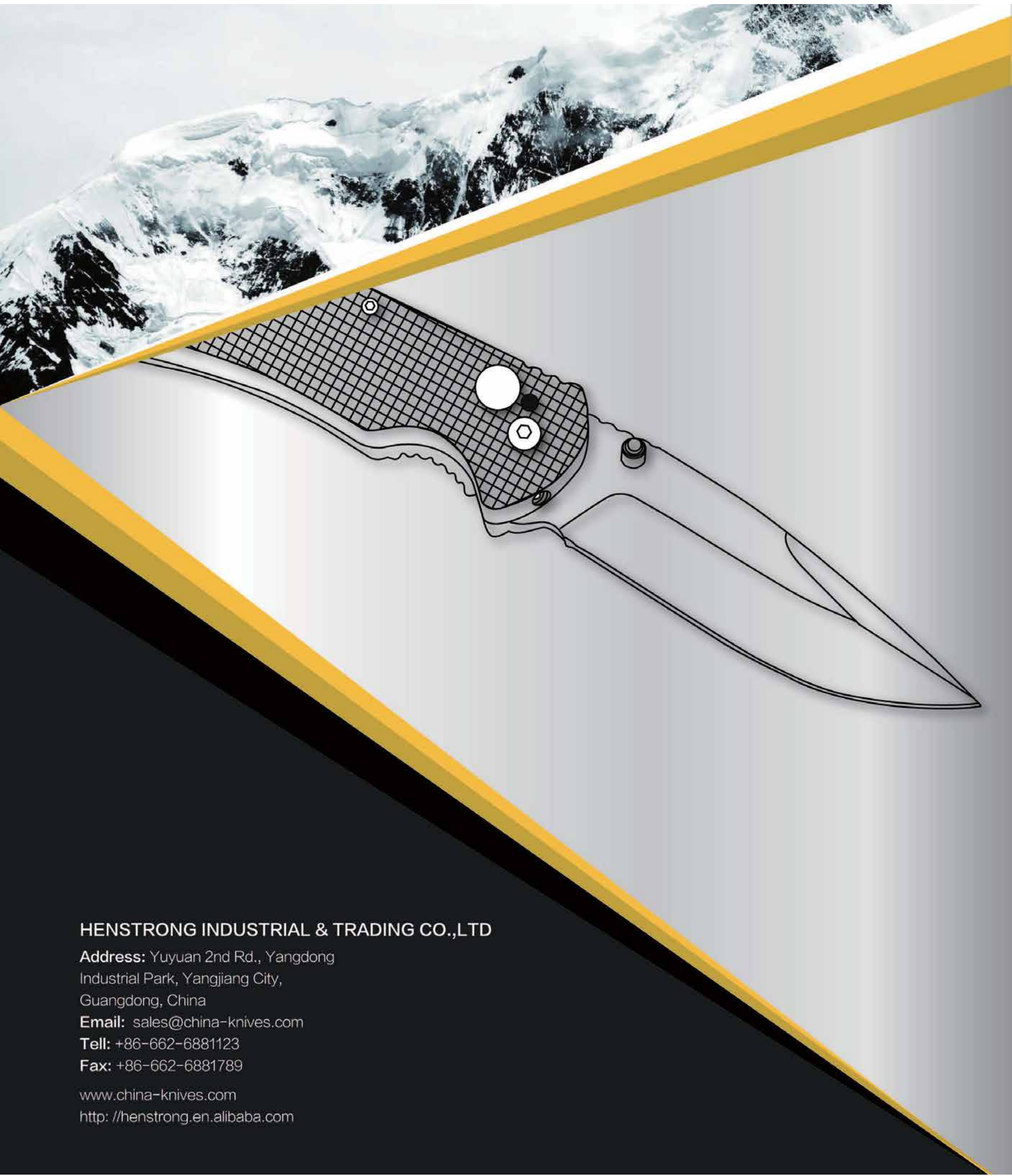

HENSTRONG INDUSTRIAL & TRADING CO.,LTD

Address: Yuyuan 2nd Rd., Yangdong
Industrial Park, Yangjiang City,
Guangdong, China

Email: sales@china-knives.com

Tell: +86-662-6881123

Fax: +86-662-6881789

www.china-knives.com

<http://henstrong.en.alibaba.com>